

# Stand-Up Safari



Collection No. PK10050  
4 Design/10 Files

# MATERIALS



## Isacord Thread Colors

- 0131 Smoke
- 0132 Dark Pewter
- 0150 Mystik Grey
- 0771 Rattan
- 0851 Old Gold
- 0853 Pecan
- 1061 Taupe

**Note: One spool of 1000 meter thread is adequate for the project unless otherwise noted.**



# MATERIALS



## Stabilizers

- OESD AquaMesh WashAway
- OESD BadgeMaster WashAway
- OESD StabilStick CutAway
- OESD Fiber Form
- OESD Applique Fuse and Fix

## Fabrics/Textiles

- Brown quilter's cotton/Cotton Shot Brown Sugar
  - (2) 5" x 6.5" PK10050-01
  - (2) 3.5" x 6.5" PK10050-02
  - (2) 4" x 4.5" PK10050-03
- Gray quilter's cotton/Cotton Shot Silver
  - (2) 5.5" x 8" PK10050-04
  - (2) 3.5" x 6" PK10050-05
  - (2) 5" x 4" PK10050-06
- Tan quilter's cotton/Cotton Shot Champagne
  - (2) 6" x 8" PK10050-07
  - (2) 5" x 6" PK10050-08
- White quilter's cotton
  - (2) 5" x 6.5" PK10050-09
  - (2) 3.5" x 7.5" PK10050-10

## Notion & Tools

- OESD Grippy GRID
- OESD Expert Embroidery Tape TearAway
- OESD Expert Embroidery Tape WashAway
- OESD Perfect Embroidery Press Cloth
- Embroidery Needle Sharp 75/11 (FSA)

## Isacord Thread Colors

- Per the thread chart
- Match bobbin thread to top thread.



# SUMMARY



Completed Size:  
Lion: 6" x 6" x 3.5"

Brown quilter's cotton/  
Cotton Shot Brown Sugar

- (2) 5" x 6.5" PK10050-01
- (2) 3.5" x 6.5" PK10050-02
- (2) 4" x 4.5" PK10050-03

PK10050-01



Requires 1 Design

PK10050-02

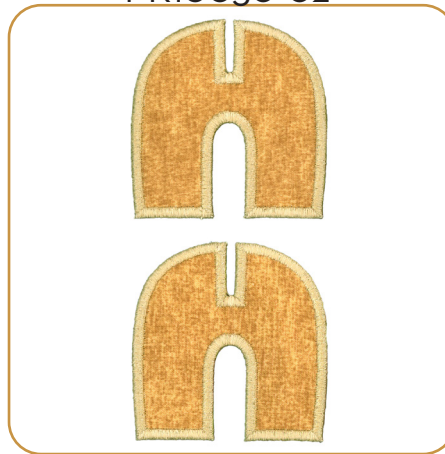

Requires 1 Design

PK10050-03



Requires 1 Design



# SUMMARY



Completed Size:  
Elephant: 7" x 6" x 4"

Gray quilter's cotton/  
Cotton Shot Silver

- (2) 5.5" x 8" PK10050-04
- (2) 3.5" x 6" PK10050-05
- (2) 5" x 4" PK10050-06

PK10050-04

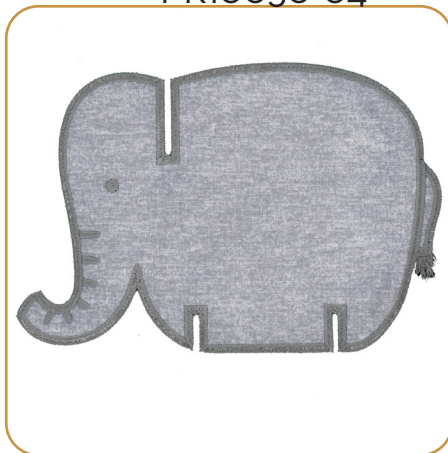

Requires 1 Design

PK10050-05

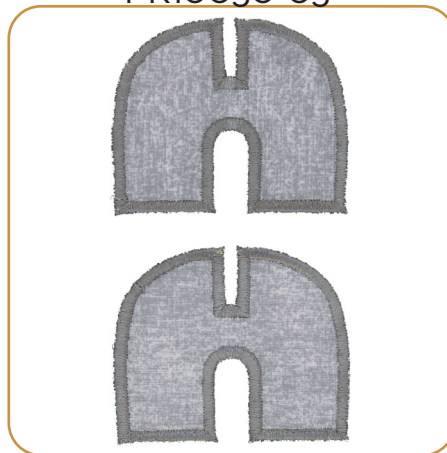

Requires 1 Design

PK10050-06

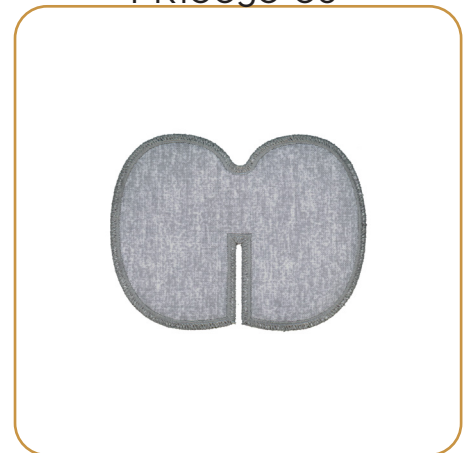

Requires 1 Design



# SUMMARY



Completed Size:  
Giraffe: 9.5" x 5" x 2.25"

Tan quilter's cotton/  
Cotton Shot Champagne

(2) 6" x 8" PK10050-07  
(2) 5" x 6" PK10050-08

PK10050-07



Requires 1 Design

PK10050-08

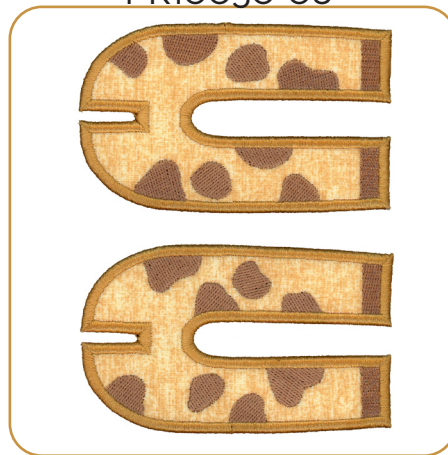

Requires 1 Design

# SUMMARY



Completed Size:  
Zebra: 6" x 5.75" x 2.75"

**White quilter's cotton**

(2) 5" x 6.5" PK10050-09  
(2) 3.5" x 7.5" PK10050-10

PK10050-09



Requires 1 Design

PK10050-10



Requires 1 Design

## General Instructions

The freestanding applique instructions, included in the collection, are general instructions. For demonstration purposes, a sample design that best demonstrates the technique is shown. Fabric and thread requirements will vary by design, but the general technique is the same. All designs are stitched with matching thread, top and bobbin.

Note: Some thread colors in instructions have been changed or digitally enhanced for better visibility.

### Step 1 - Double Sided Freestanding Applique

- Print the mirrored version of the templates (at 100% scale or 1:1 ratio) onto the paper side of Applique Fuse and Fix.
- Cut approximately 1/4" - 1/2" outside the printed applique templates.
- Cut the Fiber Form 1/4" - 1/2" larger than the applique templates.

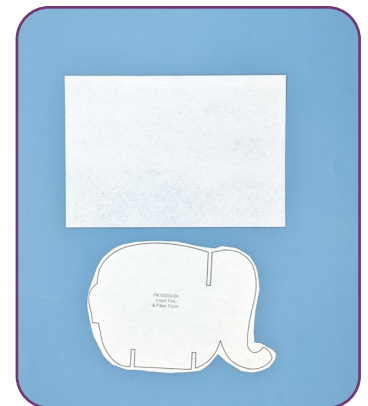

### Step 2

- Fuse the trimmed templates to the back of the Fiber Form with the paper side of the printed template up. Hold the iron on the template for 10-15 seconds for a secure fuse.





# EMBROIDERY

## Step 3

- Trim the Fiber Form on the edge of the black outline.
- Set aside.



## Step 4

- Adhere one layer of StabilStick CutAway to the wrong side of all applique fabrics to provide stiffness to the finished structure.
- Cut the prepared applique fabrics 1/4" -1/2" larger than the templates that are included at the end of the instructions.



# EMBROIDERY

## □ Step 5

- Hoop one layer of AquaMesh and one layer of BadgeMaster for all designs.

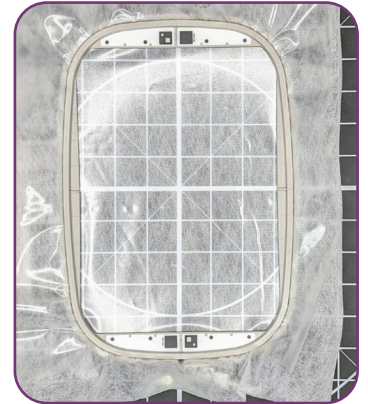

## □ Step 6

- Load selected design into the machine.
- Example design is PK10050-04.
- Thread the machine per the thread chart.
- Place the hoop on the machine.
- Stitch Machine Step 1, Fiber Form and Front/Back Gray Fabric Placement.

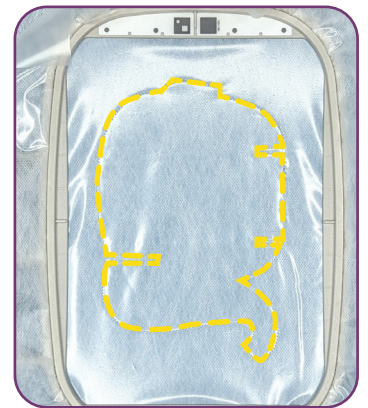

## □ Step 7

- Remove the hoop from the machine, but NOT the project from the hoop.
- Place the hoop on a flat surface.
- On the back of the Fiber Form, use the OESD Perfect Scoring Tool to score and remove the paper backing to reveal the adhesive surface.
- Place the Fiber Form within the placement stitching.
- Finger press to secure.



# EMBROIDERY

## □ Step 8

- Completely cover the Fiber Form with the prepared applique fabric.
- Tape in place to secure.



## □ Step 9

- Turn the hoop over and place the prepared applique fabric, right side up, completely covering the placement stitch.
- Carefully tape to secure.  
Tip: Avoid pushing too hard on the stabilizer to prevent it from dislodging from the hoop.



## □ Step 10

- Return the hoop to the machine.
- Stitch Machine Step 2, Cut Line and Tackdown.

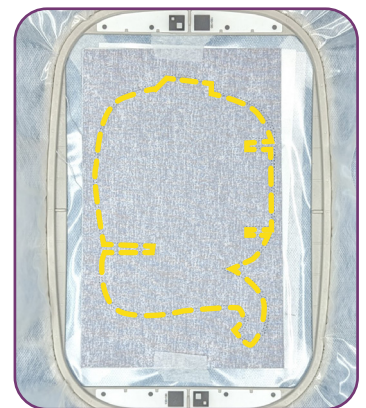

## □ Step 11

- Remove the hoop from the machine, but NOT the project from the hoop.
- Trim the excess fabric as close to the cut line as possible. If the outermost stitches (cut line) are cut, the inner stitches (tackdown) will hold the applique in place. Tip: If the stabilizer is cut or a hole is created while trimming the fabric, use OESD Expert Embroidery Tape WashAway as a patch.



## □ Step 12

- Turn the hoop over and trim the excess fabric as close to the cut line as possible.





# ASSEMBLY

## Step 15

- Rinse each piece in warm running water until the design is only slightly tacky.  
Tip: Rinse the areas of fringe longer to achieve a softer feel.
- To prevent curling, place right side down on a non-stick surface to dry. Dry completely.
- Once dry, press right side down on a Perfect Embroidery Press Cloth.

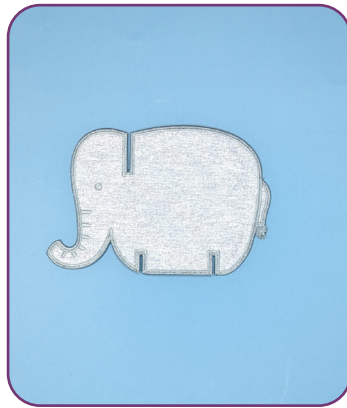

## Step 16

- Slide the Elephant Legs FSA (PK10050-05) into the leg slots on the Elephant Body FSA (PK10050-04).

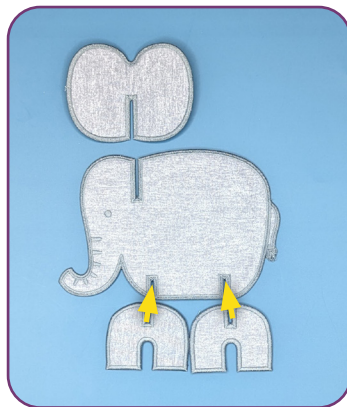

# ASSEMBLY

## □ Step 17

- Slide the Elephant Ears FSA (PK10050-06) into the ear slot on the Elephant Body FSA (PK10050-04).

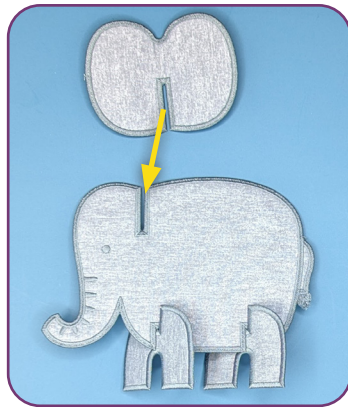

## □ Step 18

- The project is complete. Enjoy!



## ATTENTION

When printing this document, any page scaling or page fitting options in your print dialog box must be turned OFF or set to NONE so that your files will print out at their actual size. Images not printed at actual size will not function as intended.

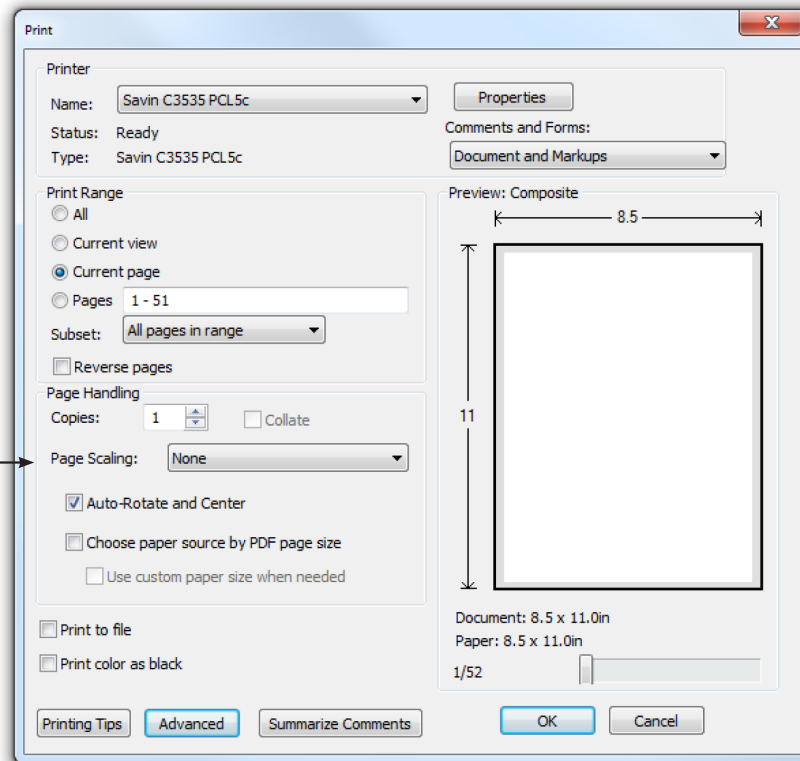

## TO SAVE PAPER

Only print the desired image by navigating to the image's page, go to File > Print and select "Current page" in the print dialog box. Repeat for each desired image.

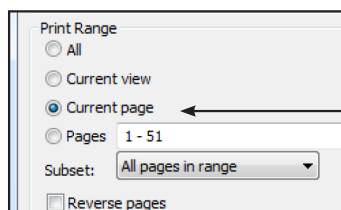



# APPLIQUE PATTERNS

OESD™ DESIGN  
PACK

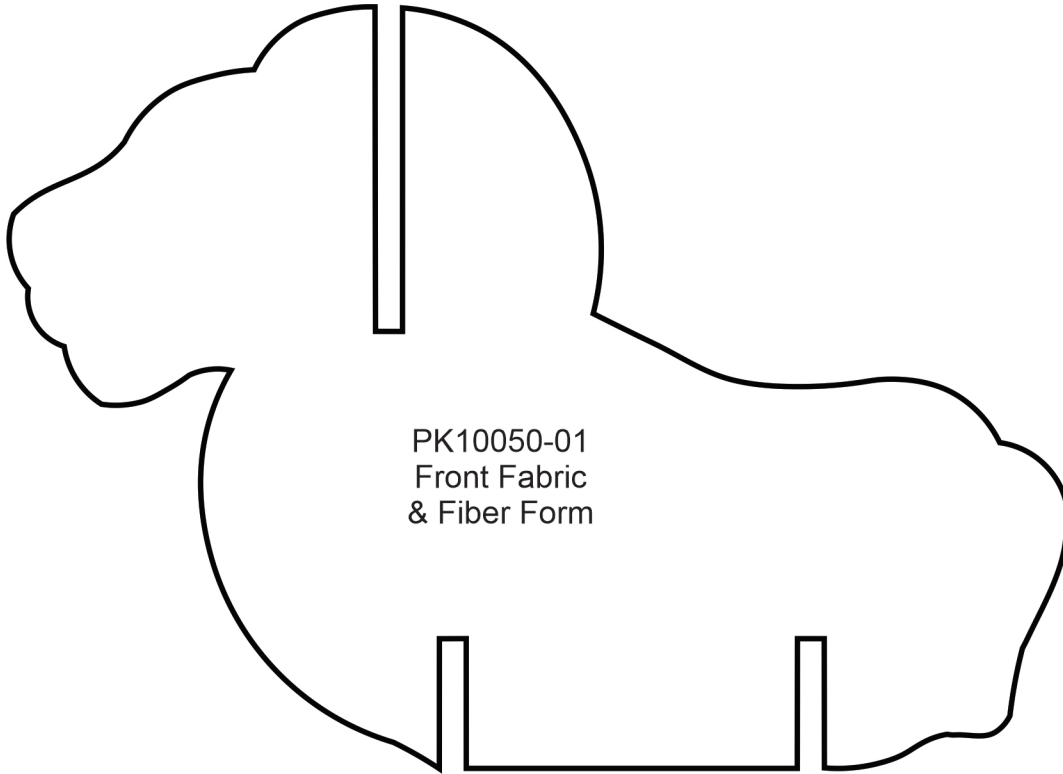

Print at 100%. No scaling. This box measures 1" x 1". Use the box as an accuracy guide when printing templates.

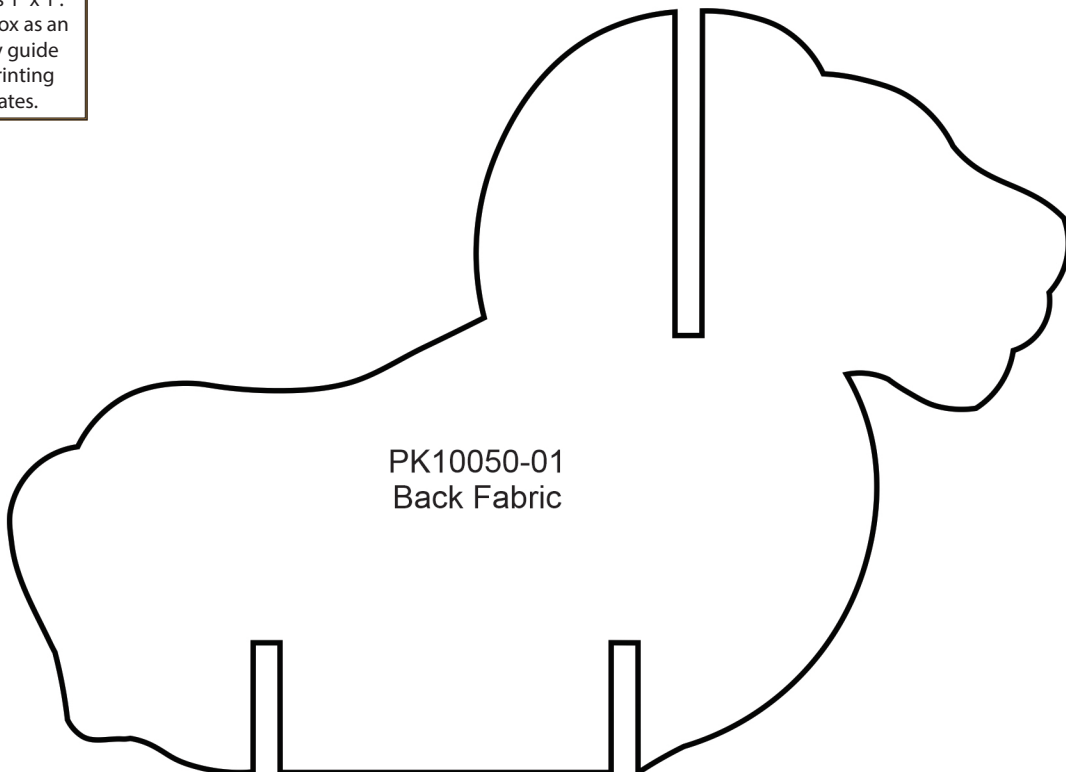

# APPLIQUE PATTERNS

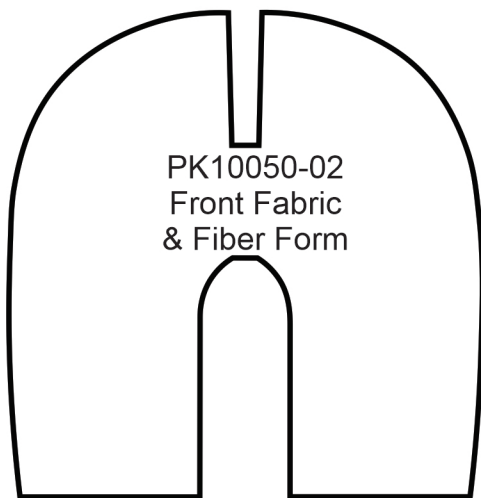
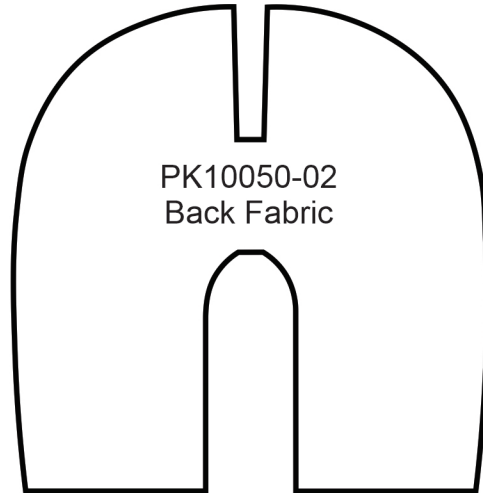
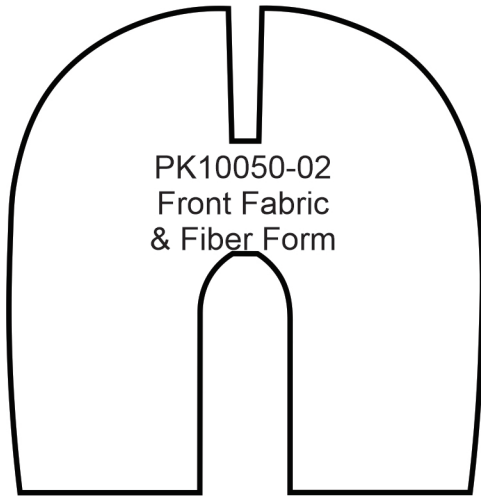

Print at 100%. No scaling. This box measures 1" x 1". Use the box as an accuracy guide when printing templates.

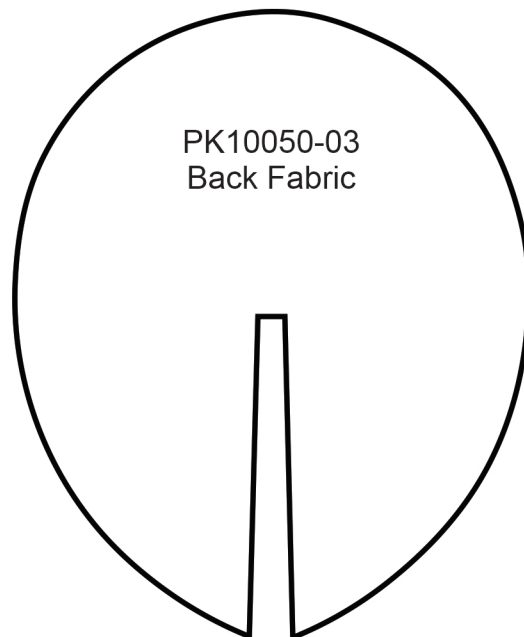
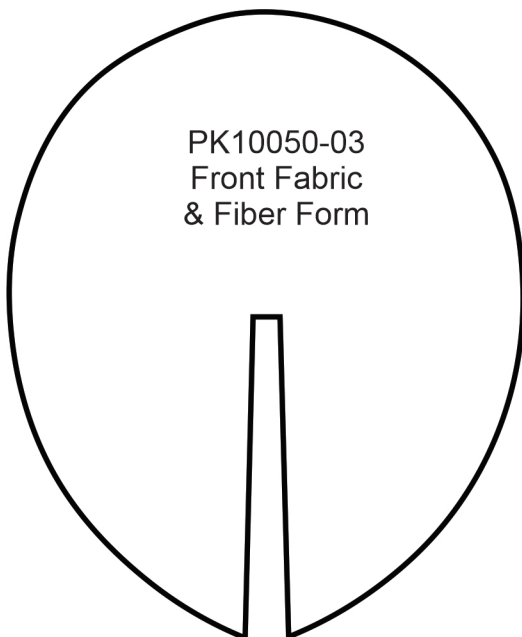

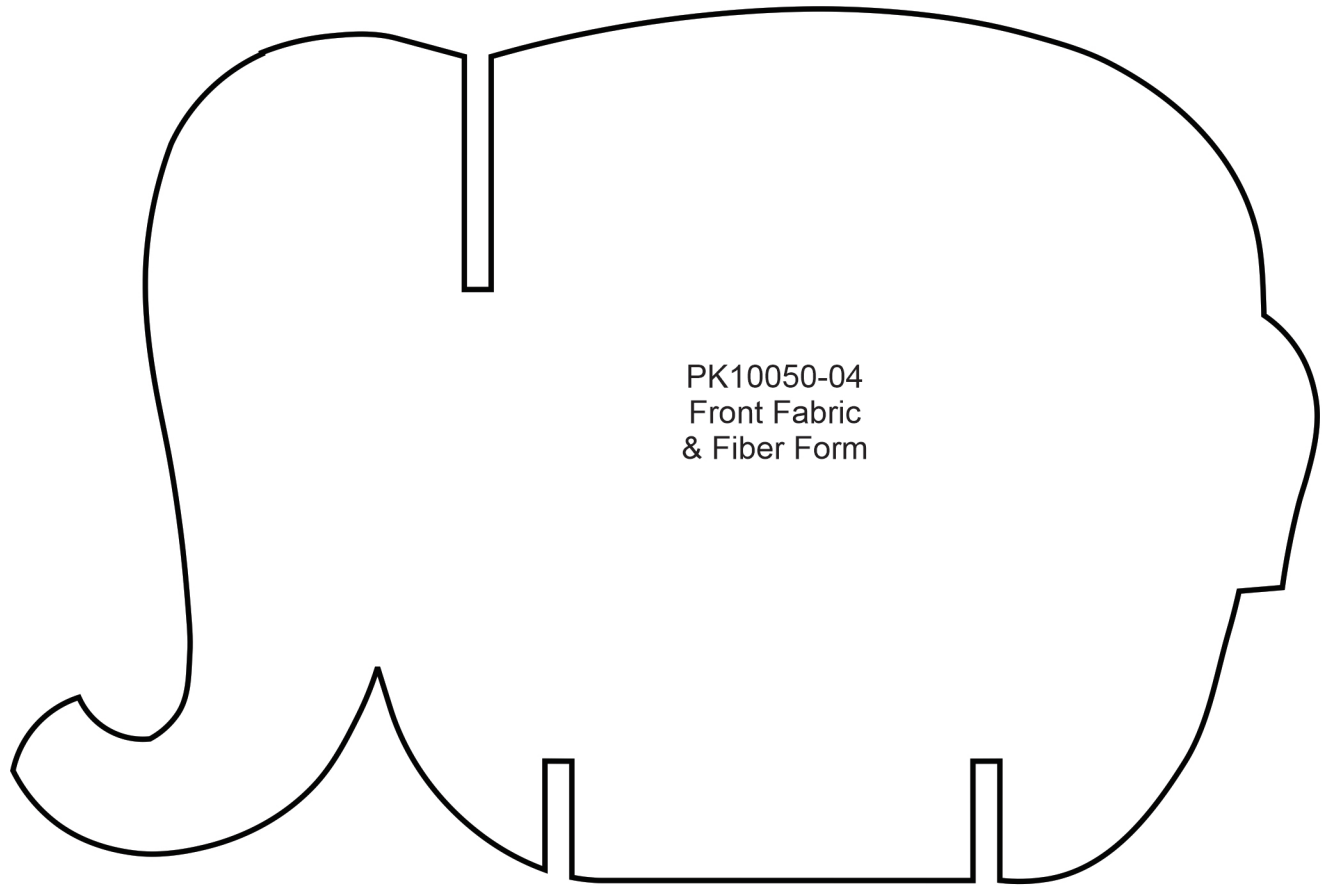

Print at 100%. No scaling. This box measures 1" x 1". Use the box as an accuracy guide when printing templates.

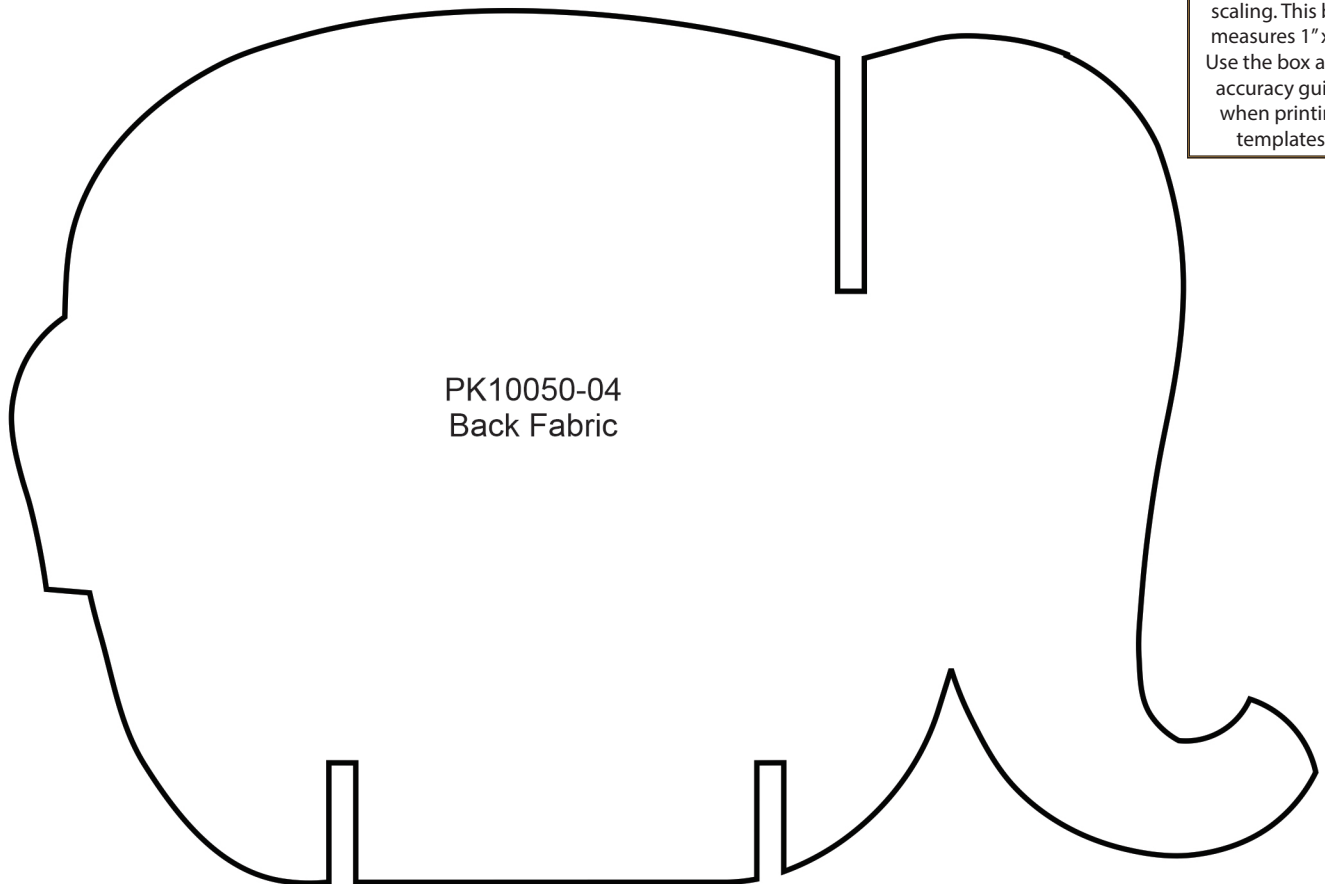

# APPLIQUE PATTERNS

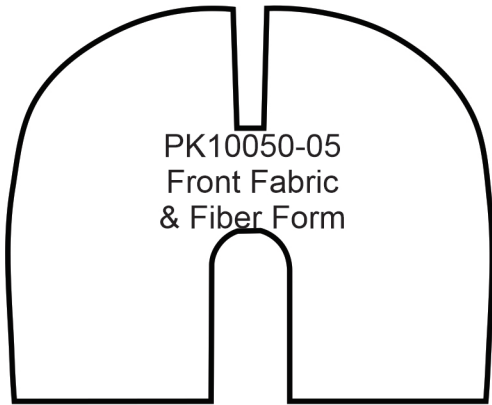

PK10050-05  
Front Fabric  
& Fiber Form

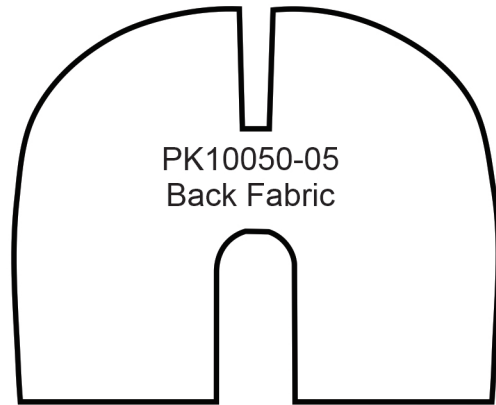

PK10050-05  
Back Fabric

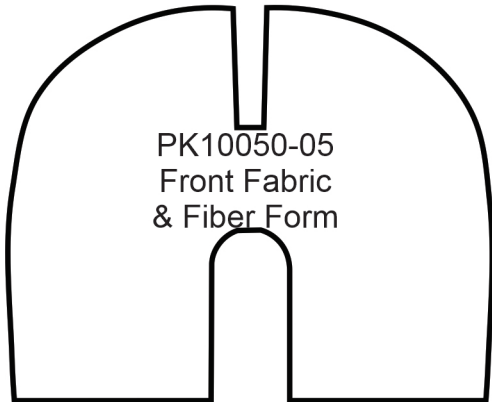

PK10050-05  
Front Fabric  
& Fiber Form

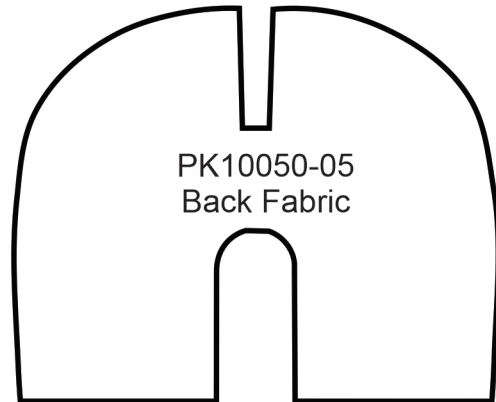

PK10050-05  
Back Fabric

Print at 100%. No scaling. This box measures 1" x 1". Use the box as an accuracy guide when printing templates.

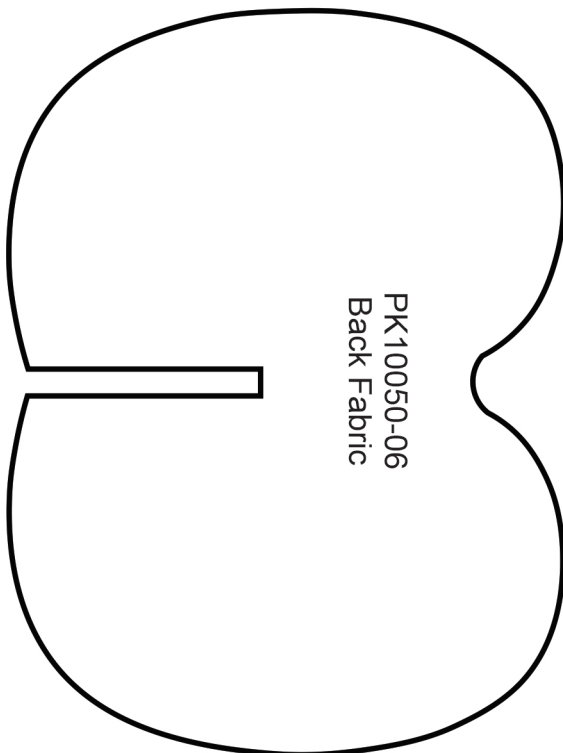

PK10050-06  
Back Fabric

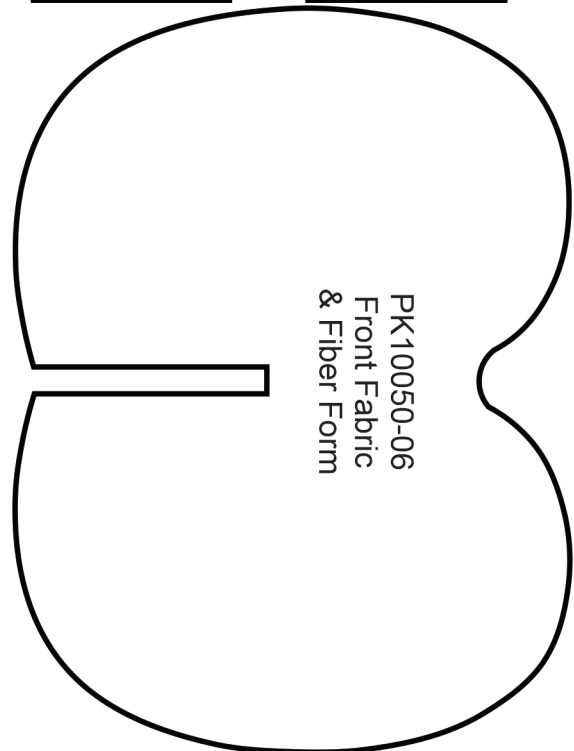

PK10050-06  
Front Fabric  
& Fiber Form

# APPLIQUE PATTERNS

Print at 100%. No scaling. This box measures 1" x 1". Use the box as an accuracy guide when printing templates.

PK10050-07  
Front Fabric  
& Fiber Form

PK10050-07  
Back Fabric

# APPLIQUE PATTERNS

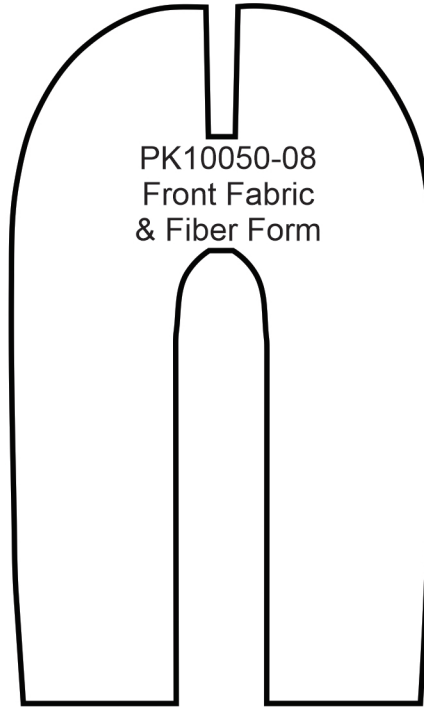
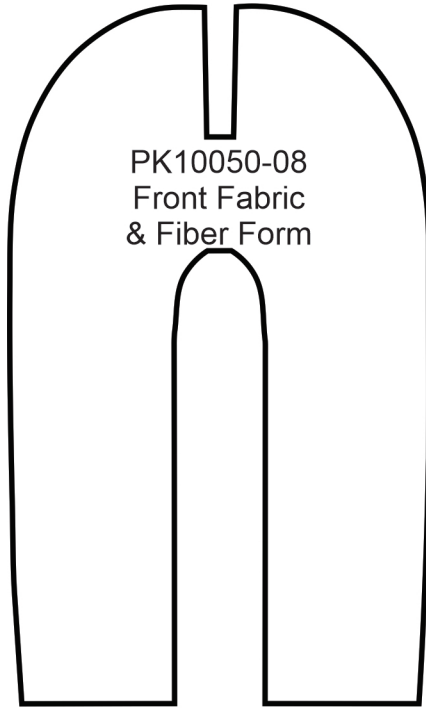

Print at 100%. No scaling. This box measures 1" x 1". Use the box as an accuracy guide when printing templates.

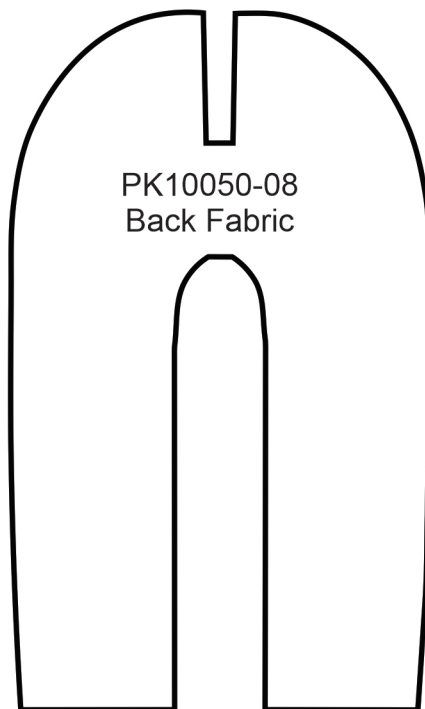
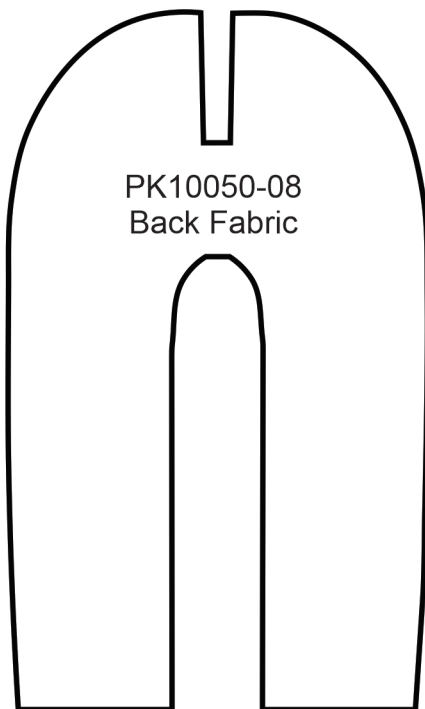

# APPLIQUE PATTERNS

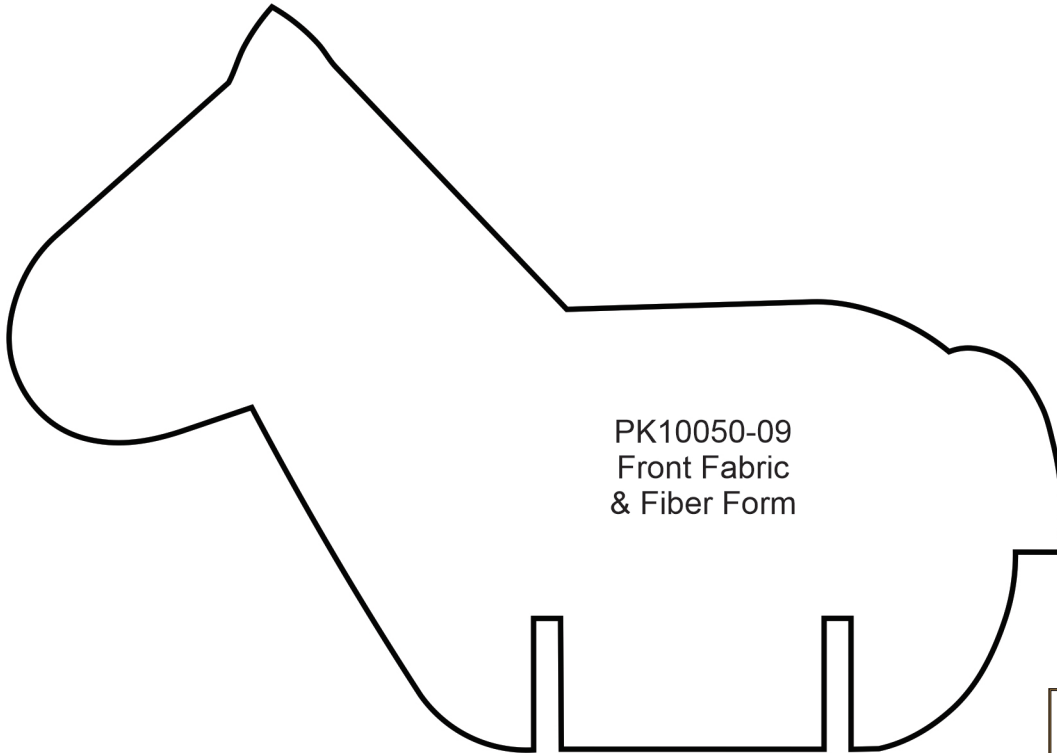

Print at 100%. No scaling. This box measures 1" x 1". Use the box as an accuracy guide when printing templates.

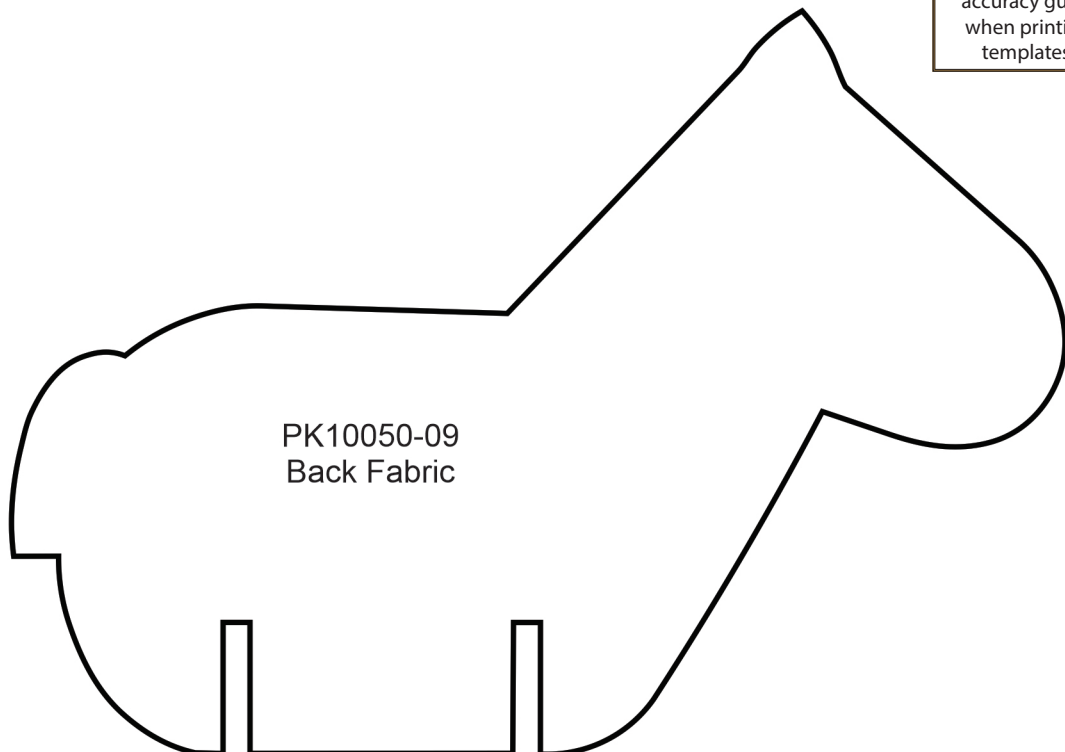

# APPLIQUE PATTERNS

Print at 100%. No scaling. This box measures 1" x 1". Use the box as an accuracy guide when printing templates.

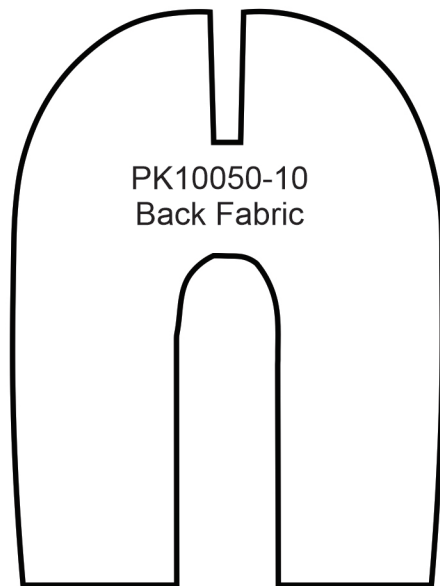
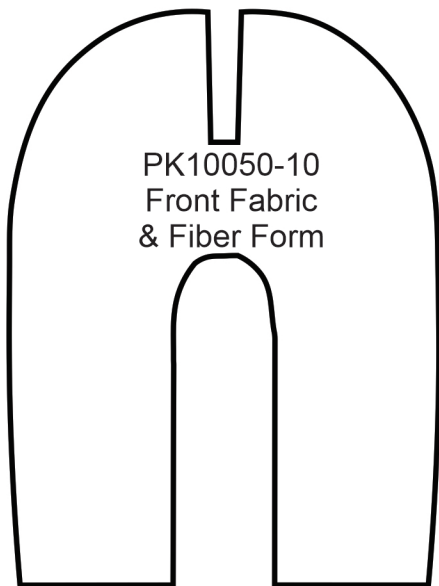
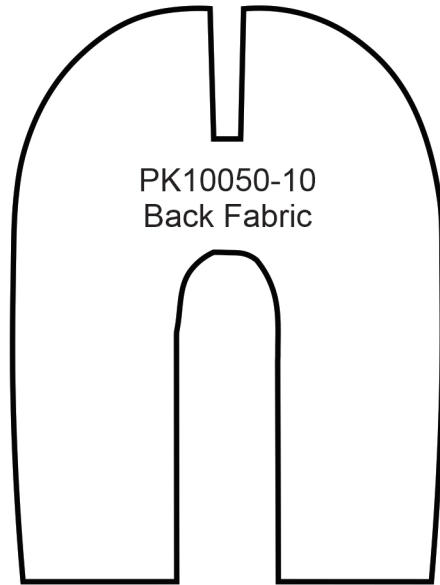
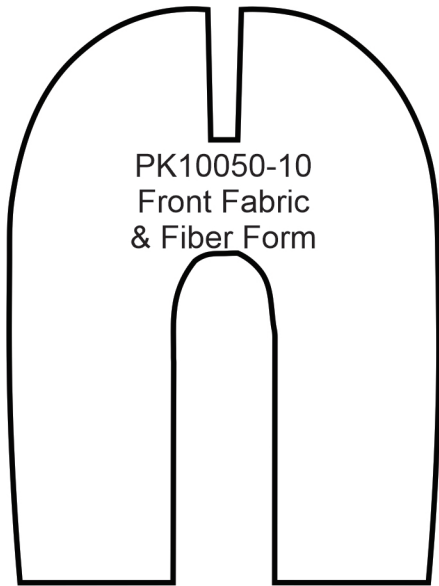



# MIRRORED PATTERNS

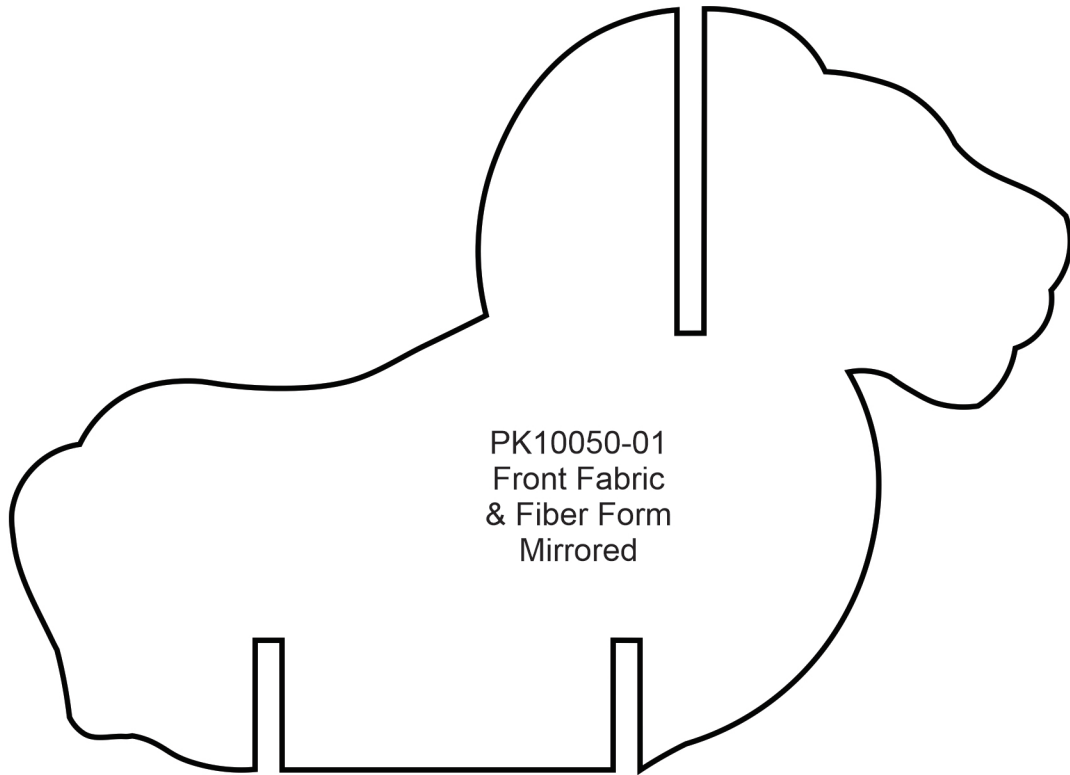

PK10050-01  
Front Fabric  
& Fiber Form  
Mirrored

Print at 100%. No scaling. This box measures 1" x 1". Use the box as an accuracy guide when printing templates.

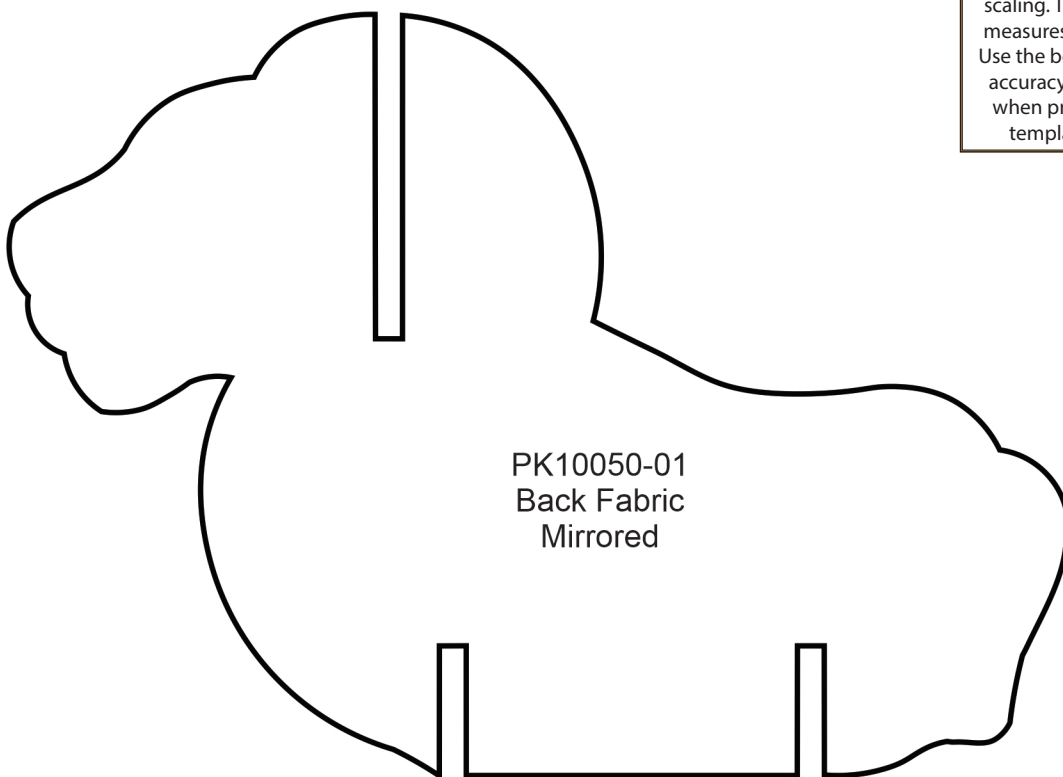

PK10050-01  
Back Fabric  
Mirrored

# MIRRORED PATTERNS

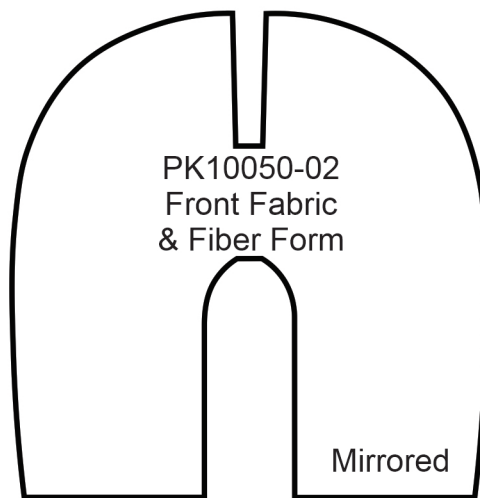
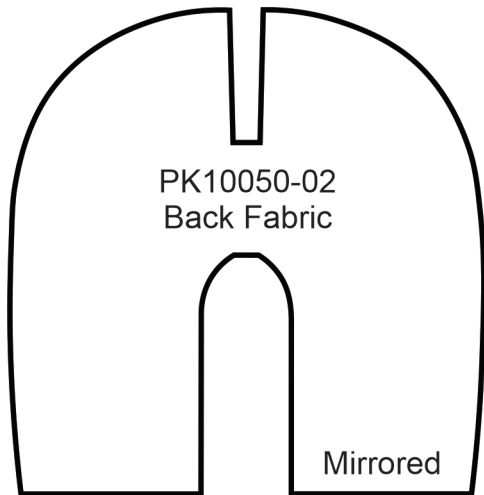
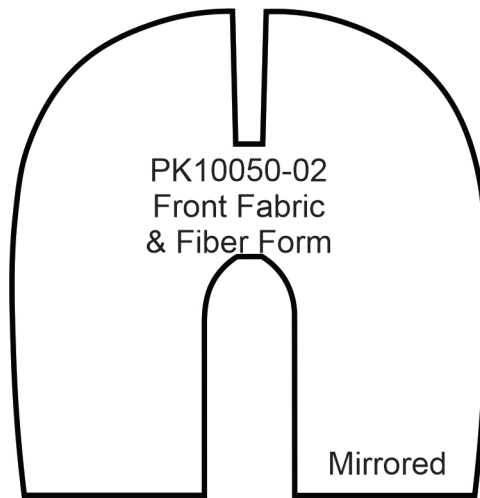
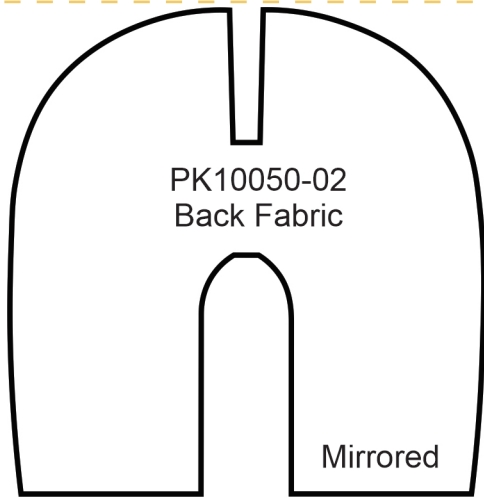

Print at 100%. No scaling. This box measures 1" x 1". Use the box as an accuracy guide when printing templates.

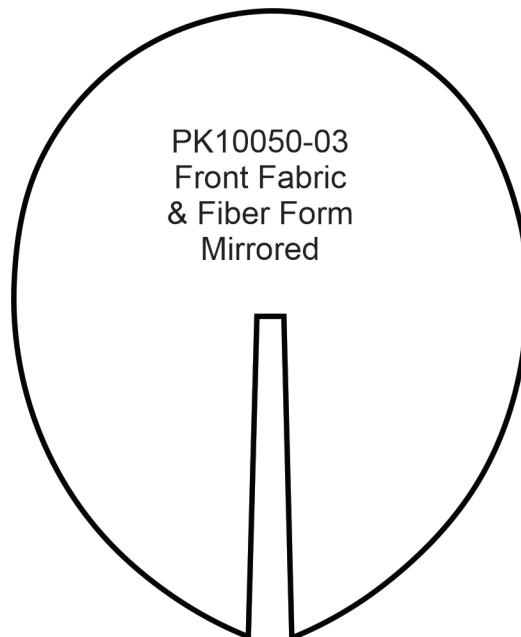
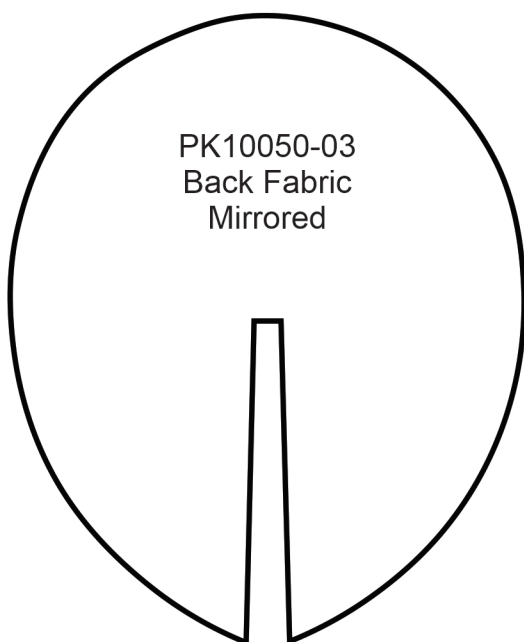

# MIRRORED PATTERNS

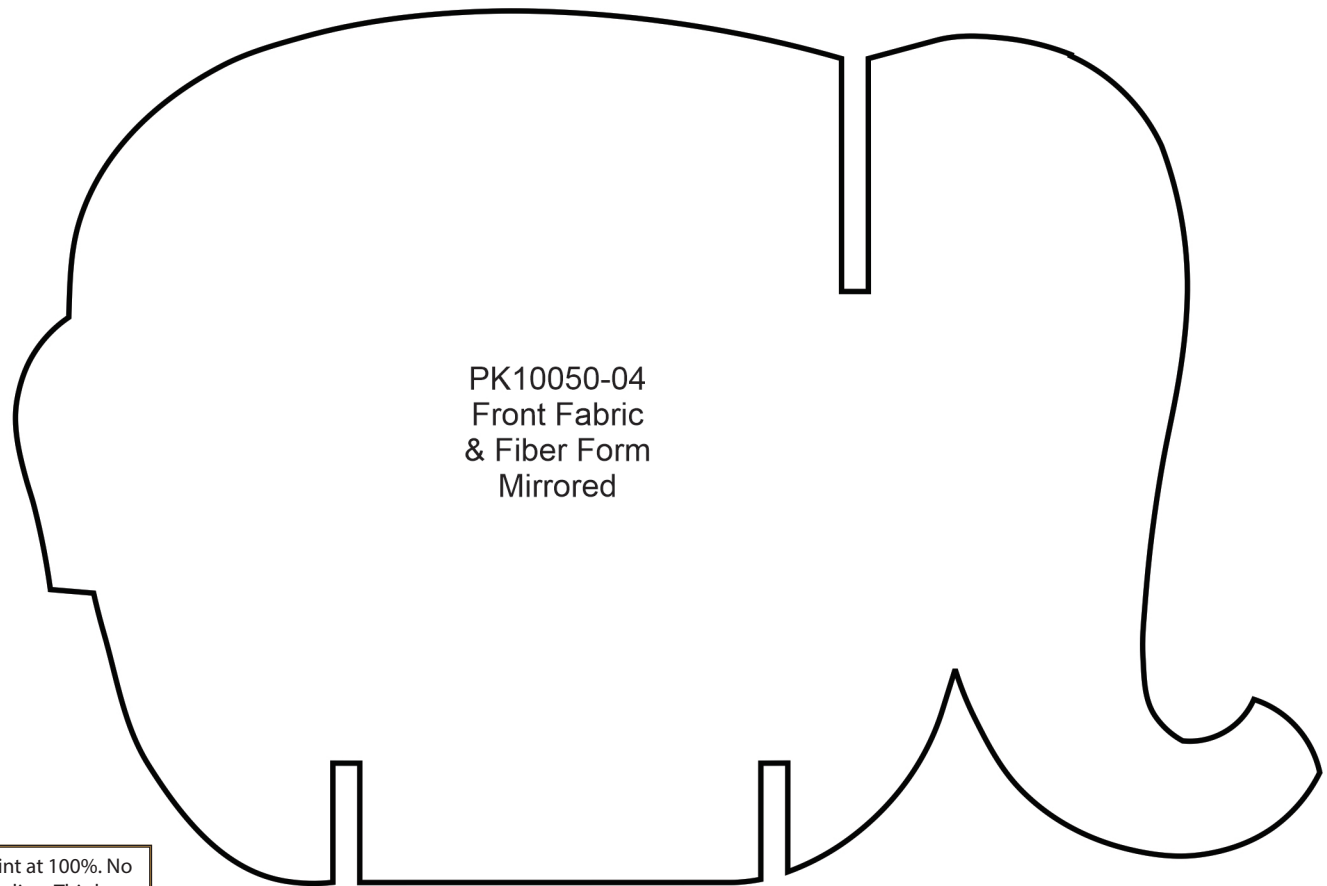

PK10050-04  
Front Fabric  
& Fiber Form  
Mirrored

Print at 100%. No scaling. This box measures 1" x 1". Use the box as an accuracy guide when printing templates.

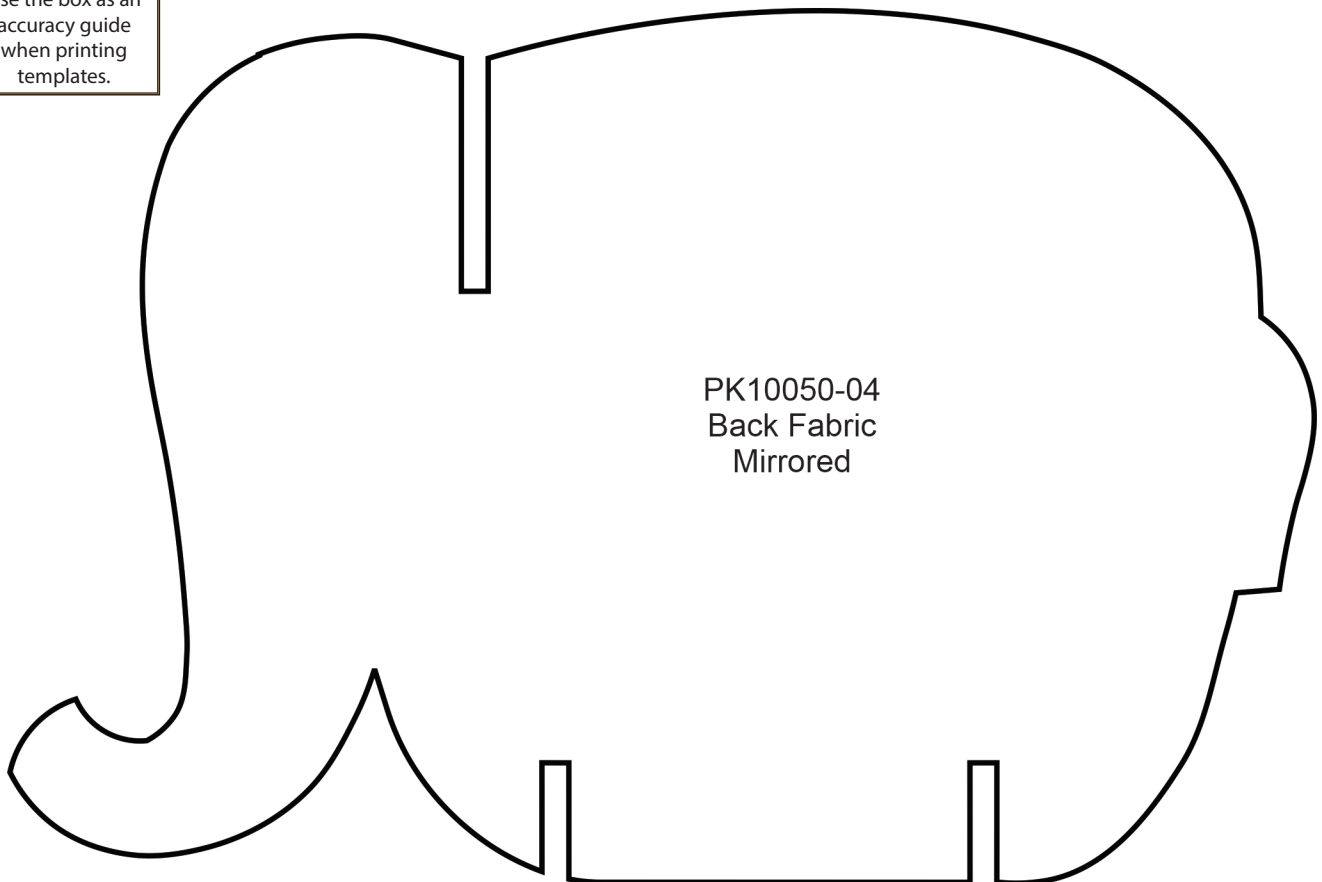

PK10050-04  
Back Fabric  
Mirrored

# MIRRORED PATTERNS

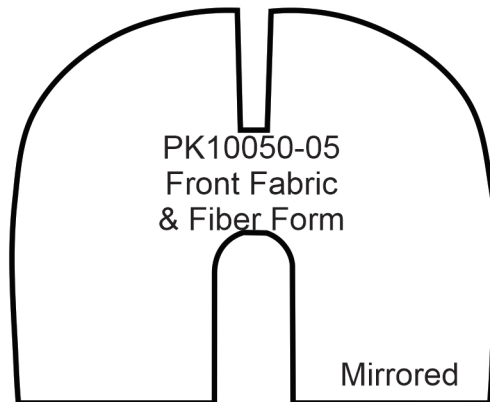
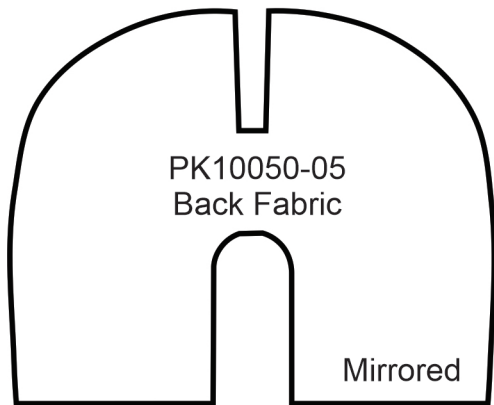
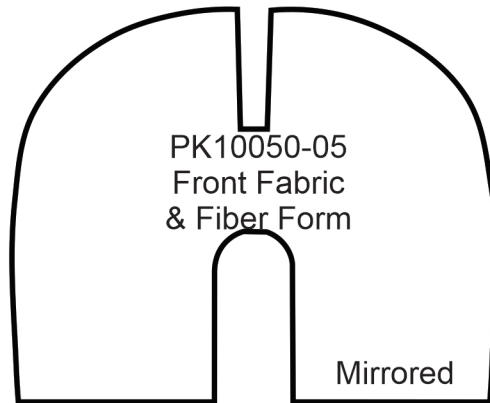
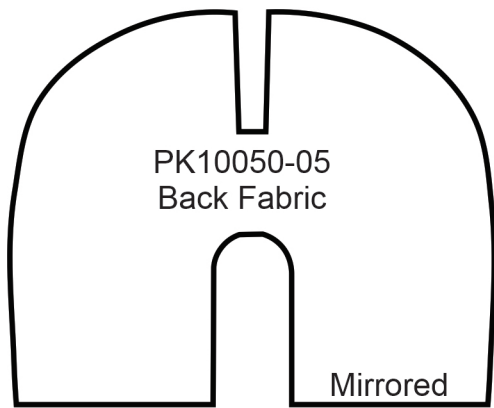

Print at 100%. No scaling. This box measures 1" x 1". Use the box as an accuracy guide when printing templates.

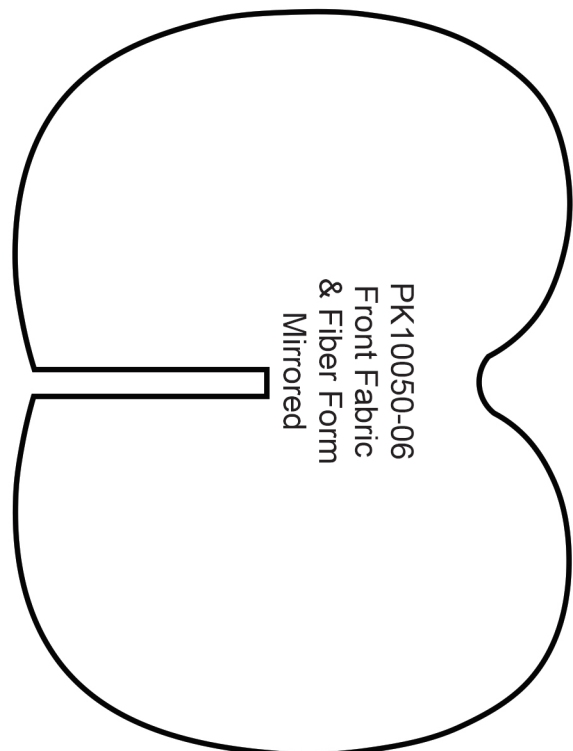
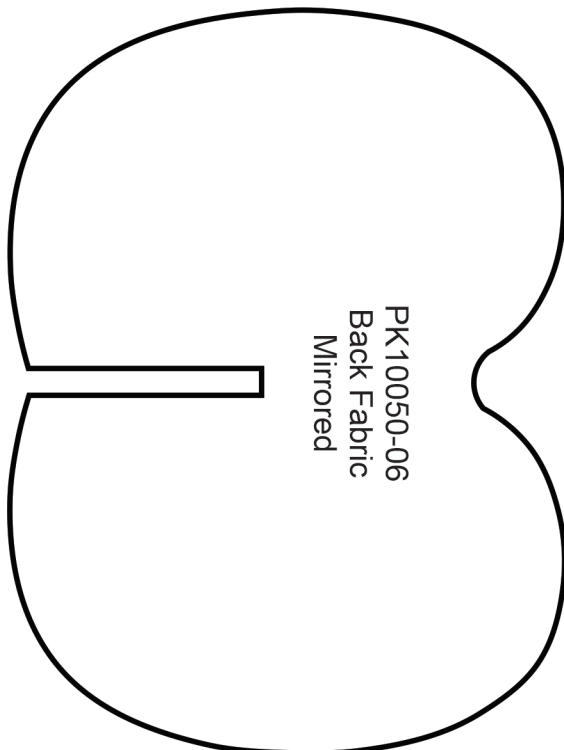

# MIRRORED PATTERNS



Print at 100%. No scaling. This box measures 1" x 1". Use the box as an accuracy guide when printing templates.

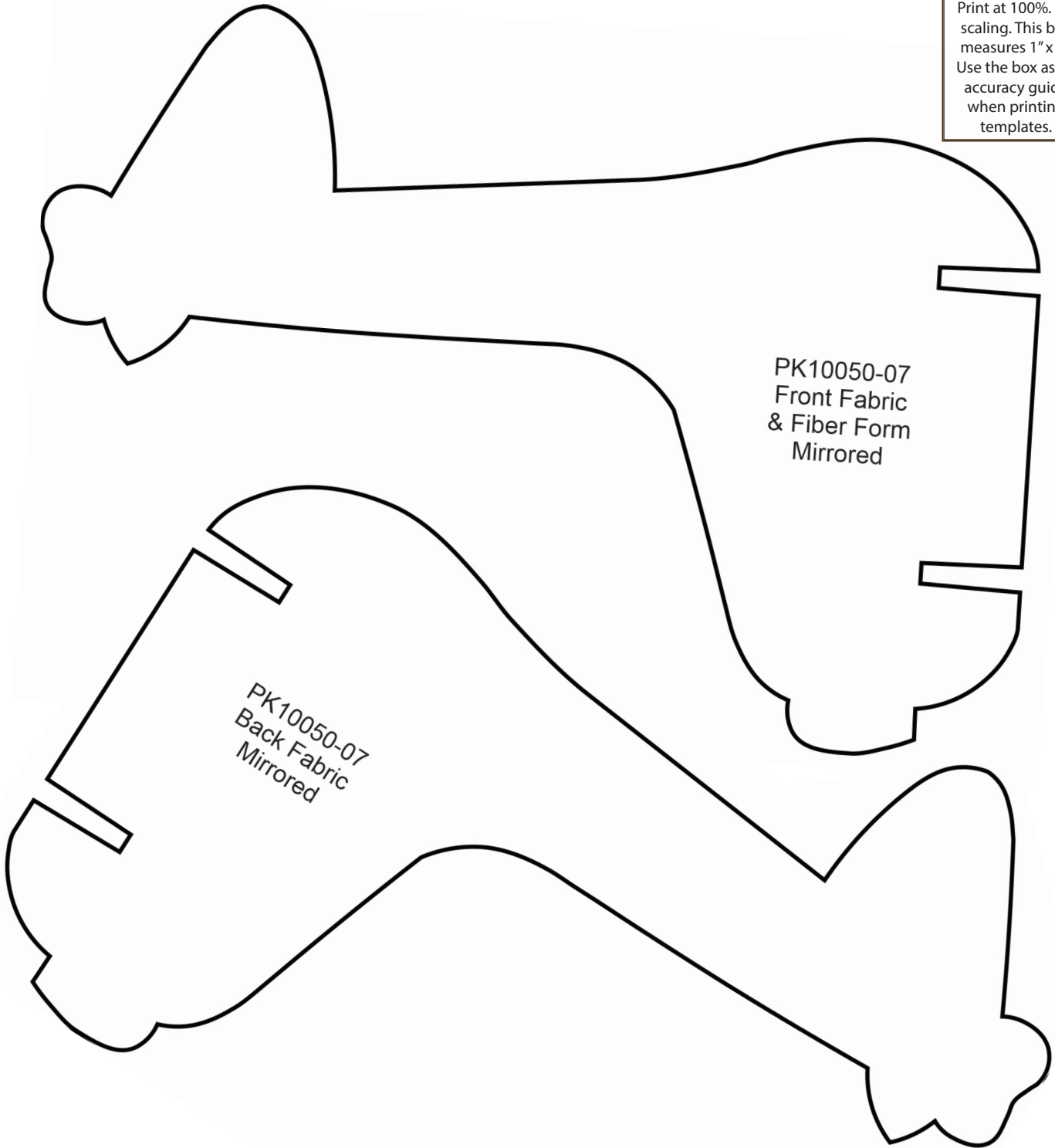

# MIRRORED PATTERNS

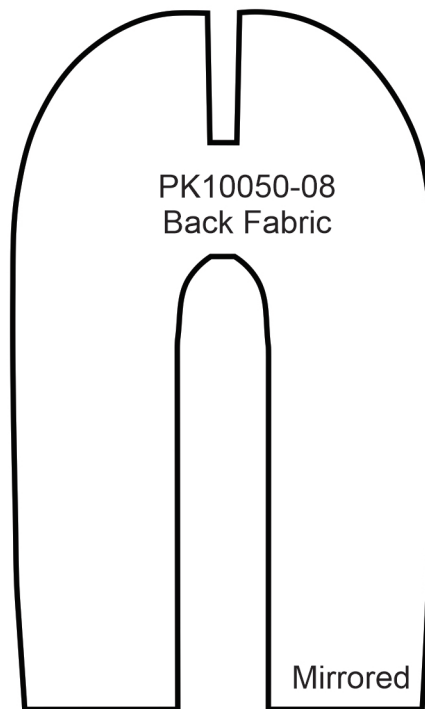
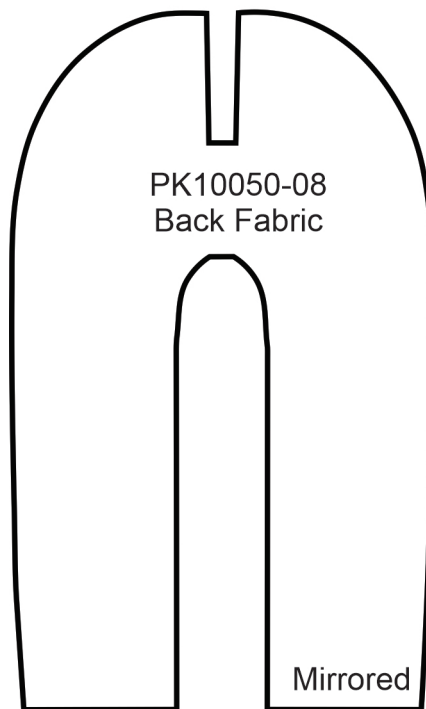
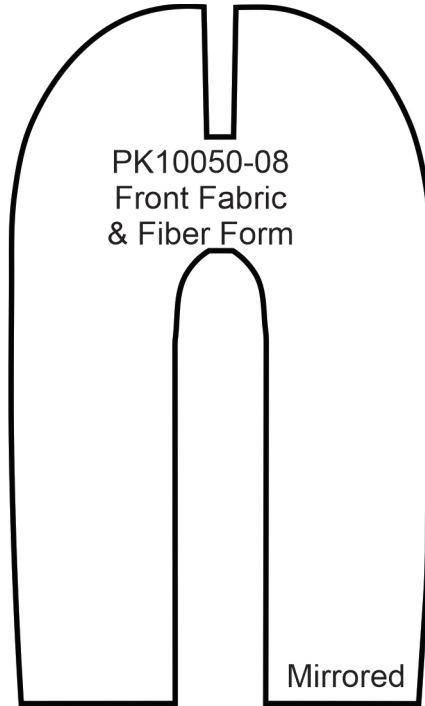
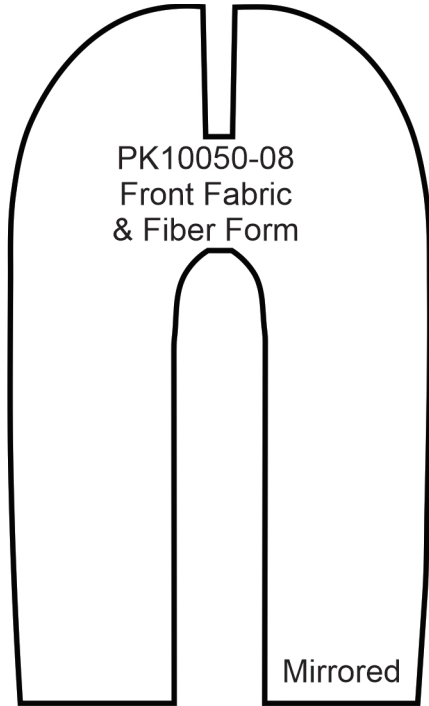

Print at 100%. No scaling. This box measures 1" x 1". Use the box as an accuracy guide when printing templates.

# MIRRORED PATTERNS

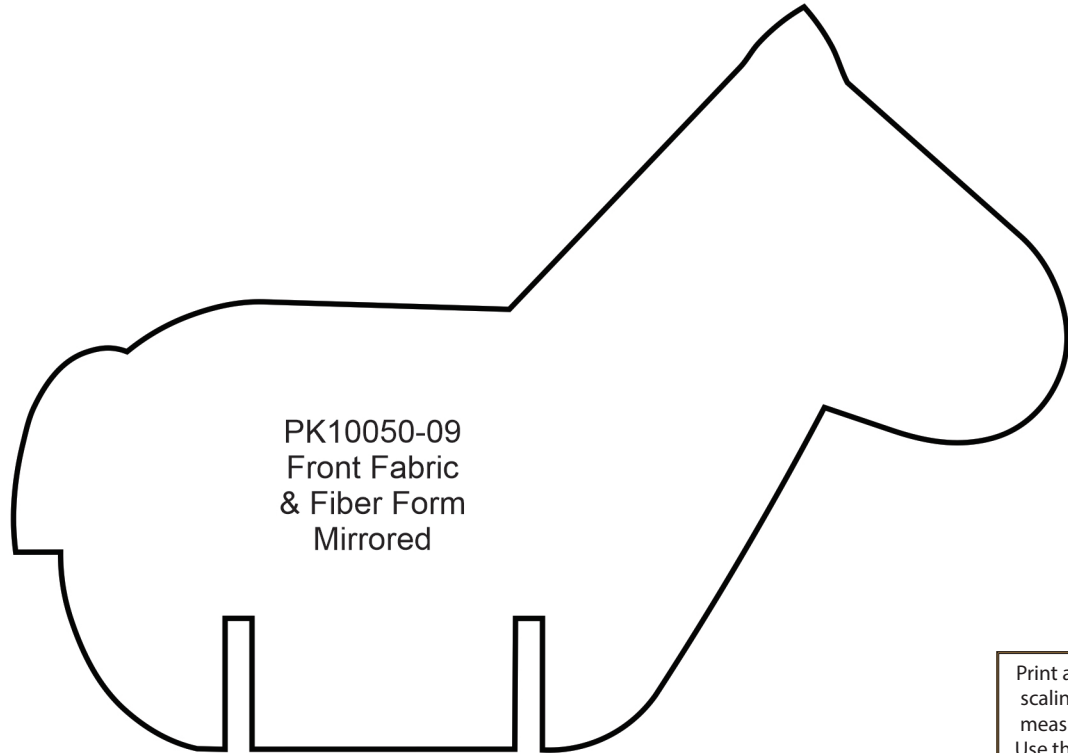

Print at 100%. No scaling. This box measures 1" x 1". Use the box as an accuracy guide when printing templates.

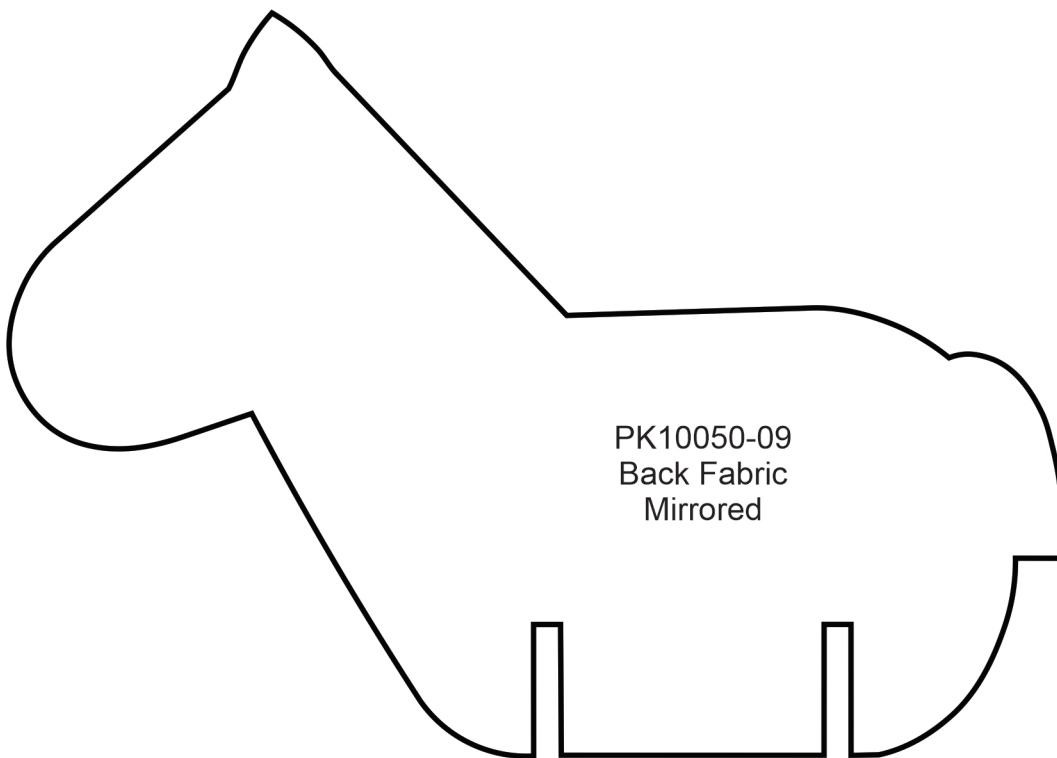

# MIRRORED PATTERNS



Print at 100%. No scaling. This box measures 1" x 1". Use the box as an accuracy guide when printing templates.

